

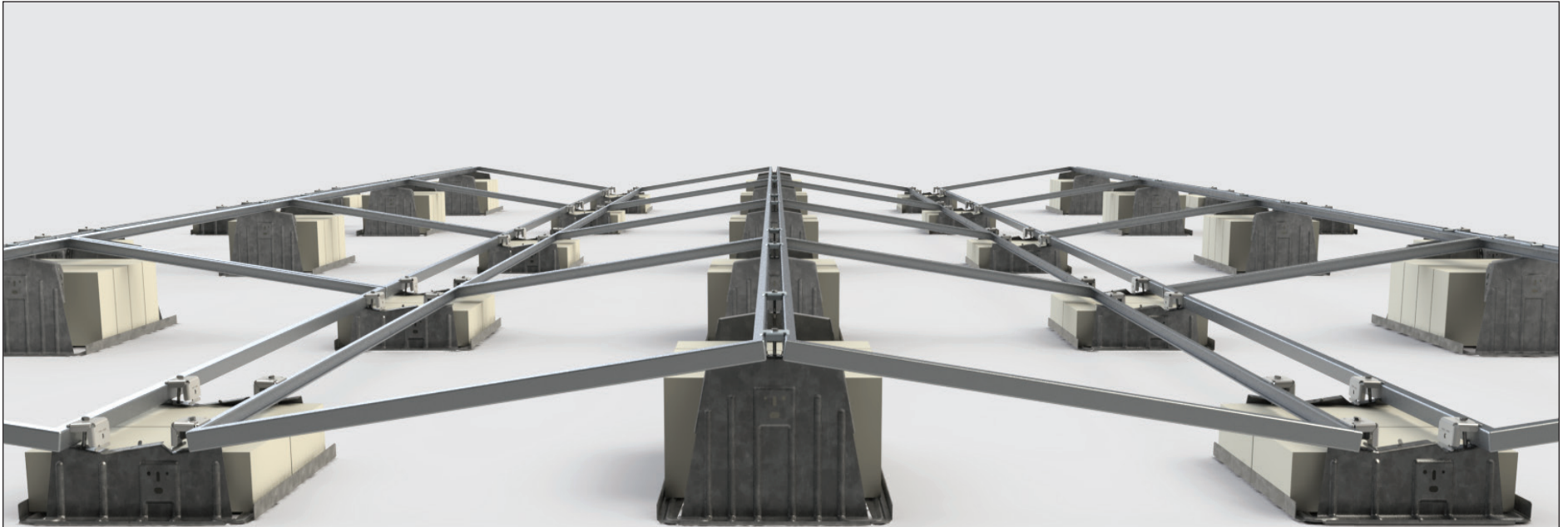

RMDT

INSTALLATION GUIDE



UL 3741 PV Hazard Control Installation Addendum

© 2022 by Unirac, Inc. All rights reserved.



INSTALLATION GUIDE

TABLE OF CONTENTS

INTRODUCTION	1
RATINGS.....	2
MARKINGS.....	3
APPROVED ELECTRICAL EQUIPMENT (UL 1741 LISTED).....	3
INTRODUCTION: UNDERSTANDING UL 3741 AND NEC 690.12	4
INSTALLATION METHODS PER UL 3741 AND NEC 690.12	5
UL 3741 LISTED SYSTEM, CASE 1	6
UL 3741 LISTED SYSTEM, CASE 2	7
UL 3741 LISTED SYSTEM, CASE 3	8
UL 3741 LISTED SYSTEM, CASE 4	9
UL 3741 WIRE MANAGEMENT GUIDELINES.....	10

INTRODUCTION

This manual describes the proper procedure to install the RMDT product to meet the requirements of the UL3741 PV Hazard Control Standard. This manual also applies to RMDT systems that include supplementary bays. All installers must thoroughly read this manual and have a clear understanding of the installation procedures prior to installation. Failure to follow the methods and procedures outlined in this guide may result in injury and/or damage to property.



**IDENTIFIES CONDITIONS OR PROCEDURES,
WHICH IF NOT FOLLOWED, COULD RESULT IN
SERIOUS INJURY, DEATH OR PROPERTY DAMAGE.**



**IDENTIFIES CONDITIONS OR PROCEDURES,
WHICH IF NOT FOLLOWED, COULD RESULT IN
SERIOUS DAMAGE OR FAILURE OF EQUIPMENT.**

IT IS THE INSTALLER'S RESPONSIBILITY TO:

- Ensure safe installation of all electrical aspects of the array. All electrical installation and procedures should be conducted by a licensed and bonded electrician or solar contractor. Routine maintenance of a module or panel shall not involve breaking or disturbing the bonding path of the system. All work must comply with national, state and local installation procedures, product, and safety standards.
- Comply with all applicable local or national building and fire codes, including any that may supersede this manual.
- Ensure that RMDT and other products are appropriate for the specific installation and are designed for the installation environment.
- PV system must be installed on a non conductive roof.
- Use only Unirac parts or parts recommended by Unirac; substituting parts may void any applicable warranty.
- Ensure provided information is accurate. Issues resulting from inaccurate information are the installer's responsibility.
- Ensure bare copper grounding wire does not contact aluminum and zinc-plated steel components, to prevent risk of galvanic corrosion.
- If loose components or loose fasteners are found during periodic inspection, re-tighten immediately. Any components showing signs of corrosion or damage that compromise safety shall be replaced immediately.
- Ensure the system is grounded and bonded to meet the requirements of the National Electric Code.
- Disconnect AC power before servicing or removing modules, AC modules, microinverters and power optimizers.
- Review module manufacturer's documentation for compatibility and compliance with warranty terms and conditions.
- Installers shall refer to the RMDT installation manual for complete installation instructions



To reduce the risk of injury, read all instructions.

RATINGS

UL3741 LISTED



Intertek

311037

CONFORMS TO STD ANSI/UL 3741

- Max PVHCS System Voltage: 1000V

RMMDT List of approved PV Hazard Control Equipment or Components evaluated at 1000V Max System Voltage:

(Not all listed items must be implemented in a single system to achieve compliance to UL3741. Rather these are the items approved for use to meet the criteria outlined in this manual)

- All Modules listed in RMMDT Installation Guide with max module area of 33.44 ft²
- RMMDT Components
 - RMMDT Bay (PN: 310801 (Ridge Bay), 310802 (Valley Bay))
 - Midclamp, (PN: 310823 (46-50mm), 310824 (41-45mm), 310825 (36-40mm), 310826 (32-35mm))
 - Endclamp (PN: 310820 (30-40mm), 310821 (41-45mm), 310822 (46-50mm))
 - 1/4-20 Clip U-Nut (PN: 310860)
- Wire Clips
 - Hellermann Tyton Cable Ties & Edge Clips (Mnfr PNs CTT60R0HSC2, 156-02224 & 156-02226)
- PV Connectors (UL 6703 Listed) shall be compatible and approved for the application.
- PV Wire (UL 4703 Listed)
- RayTray v2 Solar Wire Management System (UL 870 Listed)
- Listed Conduit (all sizes apply)
 - Electrical Metallic Tubing (EMT) (Sizes 3/4" and greater) (UL 797 Listed)
 - Rigid Metal Conduit (RMC) (Sizes 3/4" and greater) (UL 6 Listed)
 - Intermediate Metal Conduit (IMC) (Sizes 3/4" and greater) (UL 1242 listed)
 - Flexible Nonmetallic Conduit (Sizes 3/4" and greater) (UL1660 Listed)
 - PVC - Schedule 40 or 80 (Sizes 3/4" and greater) (UL 651)
 - Aluminum Channel Strut (P1000T or P1000HS EA) (UL 5B Listed)
 - Listed Tubing, Fittings and Grounding Components

MARKINGS

Product marking are located on the Ballast Bays as shown

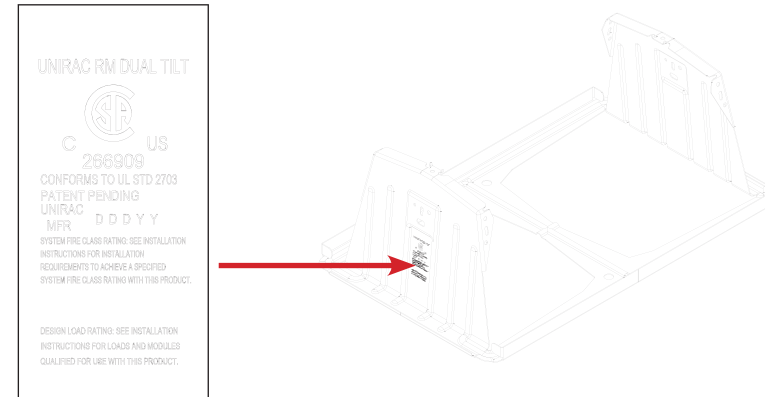

APPROVED ELECTRICAL EQUIPMENT (UL 1741 LISTED)

Canadian Solar Inverters

- CSI-25K-T480GL01-UB
- CSI-30K-T480GL01-UB
- CSI-36K-T480GL01-UB
- CSI-40K-T480GL01-UB
- CSI-50K-T480GL01-UB
- CSI-60K-T480GL01-UB
- CSI-66K-T480GL01-UB
- CSI-30KTL-GS-FLB
- CSI-40KTL-GS-FLB
- CSI-60KTL-GS-B
- CSI-75K-T480GL03-U
- CSI-80K-T480GL03-U
- CSI-90K-T480GL03-U
- CSI-100K-T480GL03-U

Chint Inverters

- CPS SCA25KTL-DO/US-208
- CPS SCA25KTL-DO-R/US-480
- CPS SCA36KTL-DO/US-480
- CPS SCA50KTL-DO/US-480
- CPS SCA60KTL-DO/US-480

Fronius Inverters

- Fronius Symo Advanced 10.0-3 208-240 (may be followed by Lite)
- Fronius Symo Advanced 12.0-3 208-240 (may be followed by Lite)
- Fronius Symo Advanced 15.0-3 480 (may be followed by Lite)
- Fronius Symo Advanced 20.0-3 480 (may be followed by Lite)
- Fronius Symo Advanced 22.7-3 480 (may be followed by Lite)
- Fronius Symo Advanced 24.0-3 480 (may be followed by Lite)

SMA Inverters

- STP 33-US-41
- STP 50-US-41
- STP 62-US-41
- STP 20-US-50
- STP 25-US-50
- STP 30-US-50

Solectria Inverters

- SolectriaRenewablesPVI25TL-208
- SolectriaRenewablesPVI25TL-480-R
- SolectriaRenewablesPVI50TL-480
- SolectriaRenewablesPVI60TL-480

Sungrow Inverters

- SG36CX-US
- SG60CX-US

Solis Inverters

- Solis-25K-US (followed by -US-SW, -US-F-SW or -US-LSW)
- Solis-30K-US (followed by -US-SW, -US-F-SW or -US-LSW)
- Solis-36K-US (followed by -US-SW, -US-F-SW or -US-LSW)
- Solis-40K-US (followed by -US-SW, -US-F-SW or -US-LSW)
- Solis-50K-US (followed by -US-SW, -US-F-SW, -US-F-LSW or -US-LSW)
- Solis-60K-US (followed by -US-F-SW, or -US-F-LSW)
- Solis-66K-US (followed by -US-F-SW, or -US-F-LSW)

GoodWe Inverters

- GW50K-SMT-US
- GW60K-SMT-US
- GW6000A-MS
- GW7600A-MS
- GW8600A-MS
- GW9600A-MS

INTRODUCTION: UNDERSTANDING UL 3741 AND NEC 690.12**2020 NEC 690.12(B)(2) Controlling Conductors within the array boundary**

The RMDT Photovoltaic Hazard Control System (PVHCS) is a UL 3741 Listed system that complies with NEC 690.12(B)(2)(1), when installed by qualified persons per the installation procedures outlined in the RMDT System Installation Manual and this Addendum. Ensure that all PVRSE, including inverters, are contained within the array boundary per NEC 690.12. Please refer to the following pages of this addendum for various example cases of system designs that comply with 690.12(B)(2).

2020 NEC 690.12 Background

2020 NEC 690.12 Rapid Shutdown of PV Systems on Buildings requires that all PV arrays installed on or in buildings shall include rapid shutdown functions to reduce shock hazard for Fire Fighters (FF) in accordance with 690.12(A) through (D):

A. Controlled Conductors

- (1) PV system DC circuits
- (2) Inverter output circuits originating from inverters located within array boundary

B. Controlled Limits

- (1) Outside Array Boundary: $\leq 30V$ within 30 seconds
- (2) Inside Array Boundary:
 - (1) Listed PV Hazard Control System (UL 3741)
 - (2) $\leq 80V$ within 30 seconds after rapid shutdown initiation
 - (3) PV array without exposed wiring methods or conductive parts

C. Initiation devices

- Initiation device(s) shall initiate the rapid shutdown function of the PV system

D. Equipment

- Equipment that performs rapid shutdown functions other than initiation devices, such as listed disconnect switches, circuit breakers, or control switches.

E. NEC defines the array as a mechanically and electrically integrated grouping of modules with support structure, including any attached system components such as inverter(s) or dc-to-dc converter(s) and attached associated wiring. This indicates the RMDT Racking and collocated inverters are part of the array.

F. NEC 690.12(B) defines the array boundary as 1ft from array in all directions. This indicates that the array boundary can extend 1ft from the edge of the RMDT racking, inverter or module.



INSTALLATION METHODS PER UL 3741 AND NEC 690.12

The following case studies are provided and recommended by Unirac to show examples of installation configurations that comply with NEC 690.12(B). Compliance is not limited to these examples.

Case 1: UL 3741 Listed System – **See page 6**

Case 2: UL 3741 Listed System with Contiguous Sub-Array – **See page 7**

Case 3: UL 3741 Listed System with Non-Contiguous Sub-Array – **See page 8**

Case 4: UL 3741 Listed System with MLPE Sub-Array – **See page 9**

The simplest installation method to comply with NEC690.12(B) is to utilize the RMDT UL 3741 system with a contiguous array with one or more collocated inverters, as all inverter DC input circuits are within the 1ft array boundary (Case 1). Installations where sub-arrays are required and cannot be included within the 1ft array boundary can comply by using a single or combining one or more of the three options below (Cases 2-4).

UL 3741 LISTED SYSTEM, CASE 1

Array(s) comply with NEC 690.12(B)(2)(1)

PV Circuit Voltages

- Outside Array Boundary: $\leq 30V$ within 30 seconds
- Inside Array Boundary: $\leq 1000V$

Case 1: Array(s) complies with 690.12(B) by utilizing a listed UL 3741 PV Hazard Control System

- All inverter input circuits (DC) are contained within the PV array boundary and do not require additional measures to reduce string voltages per 690.12(B)(2)(1) after initiation (Inverter DC disconnect, AC breaker or AC disconnect).
- Inverter output circuits (AC) are outside of the array boundary and meet the 690.12(B)(1) requirement after initiation (AC breaker or AC disconnect).

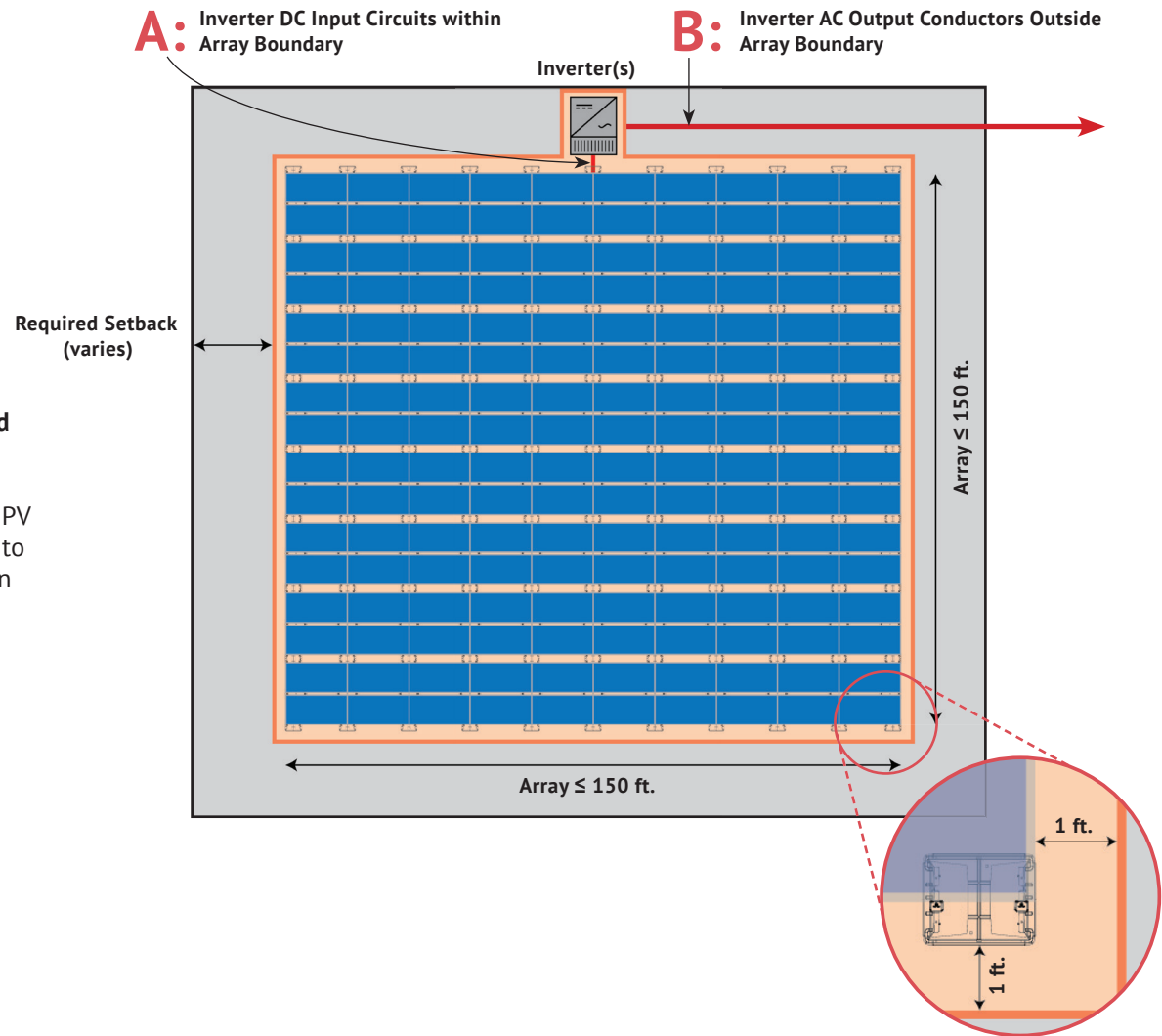

UL 3741 LISTED SYSTEM, CASE 2

Sub-Array(s) are within the same Array Boundary and Array(s) comply with NEC 690.12(B)(2)(1)

PV Circuit Voltages

- Outside Array Boundary: $\leq 30V$ within 30 seconds
- Inside Array Boundary: $\leq 1000V$

Case 2: Maintaining NEC Compliance with sub-array(s) within array boundary

Maximum 2 ft. spacing between all array components resulting in a single array boundary.

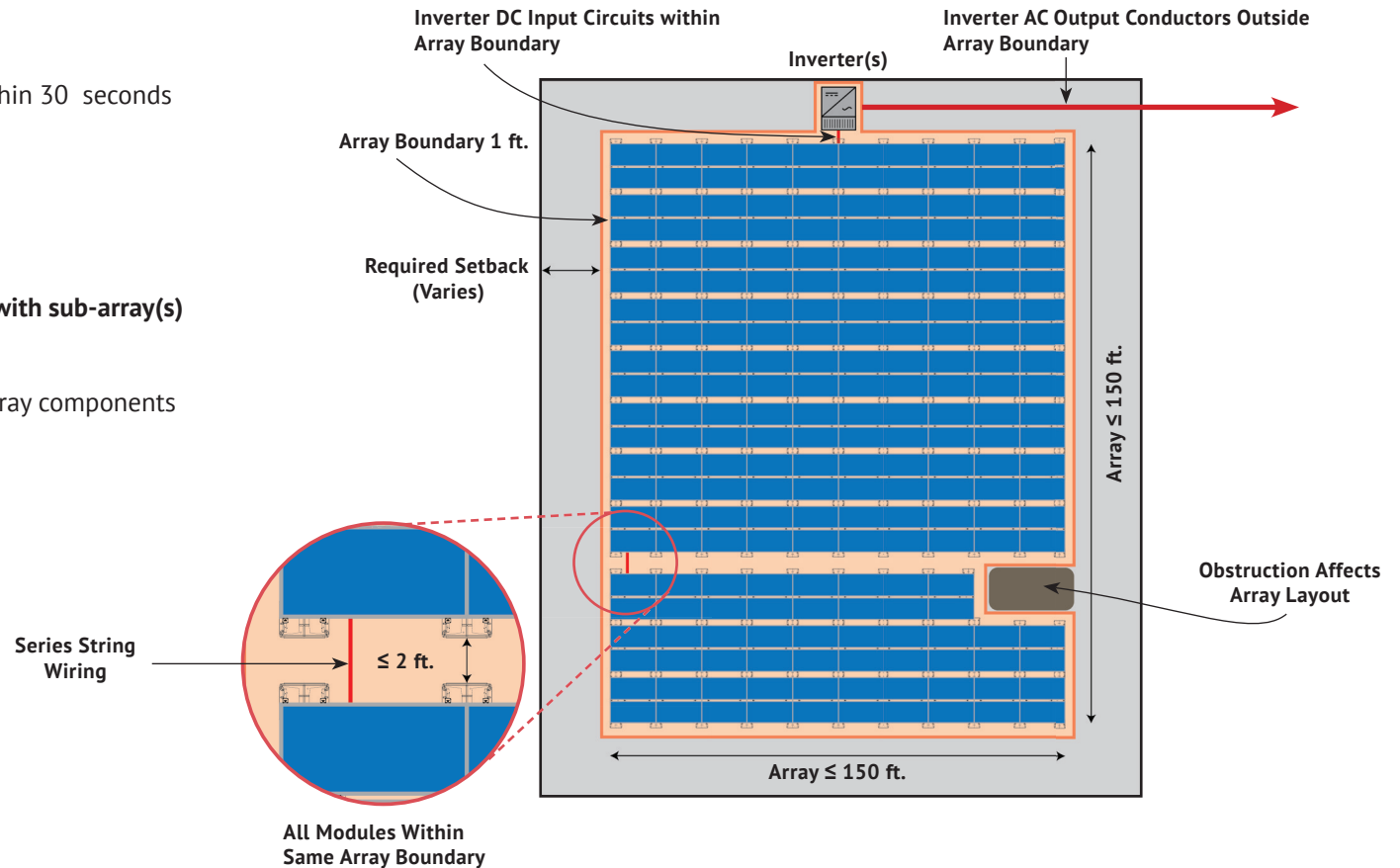

UL 3741 LISTED SYSTEM, CASE 3

Multiple Sub-Arrays with conductors outside of Array Boundary are controlled via String Isolation Device(s)

PV Circuit Voltages

- Outside Array Boundary: $\leq 30V$ within 30 seconds
- Inside Array Boundary: $\leq 1000V$

Case 3: Maintaining NEC Compliance with sub-array(s) outside of array boundary

Complete string must be connected to a single isolation device. If used for a partial string, isolation devices required on both sides of the pathway since voltage will be present on both sides.

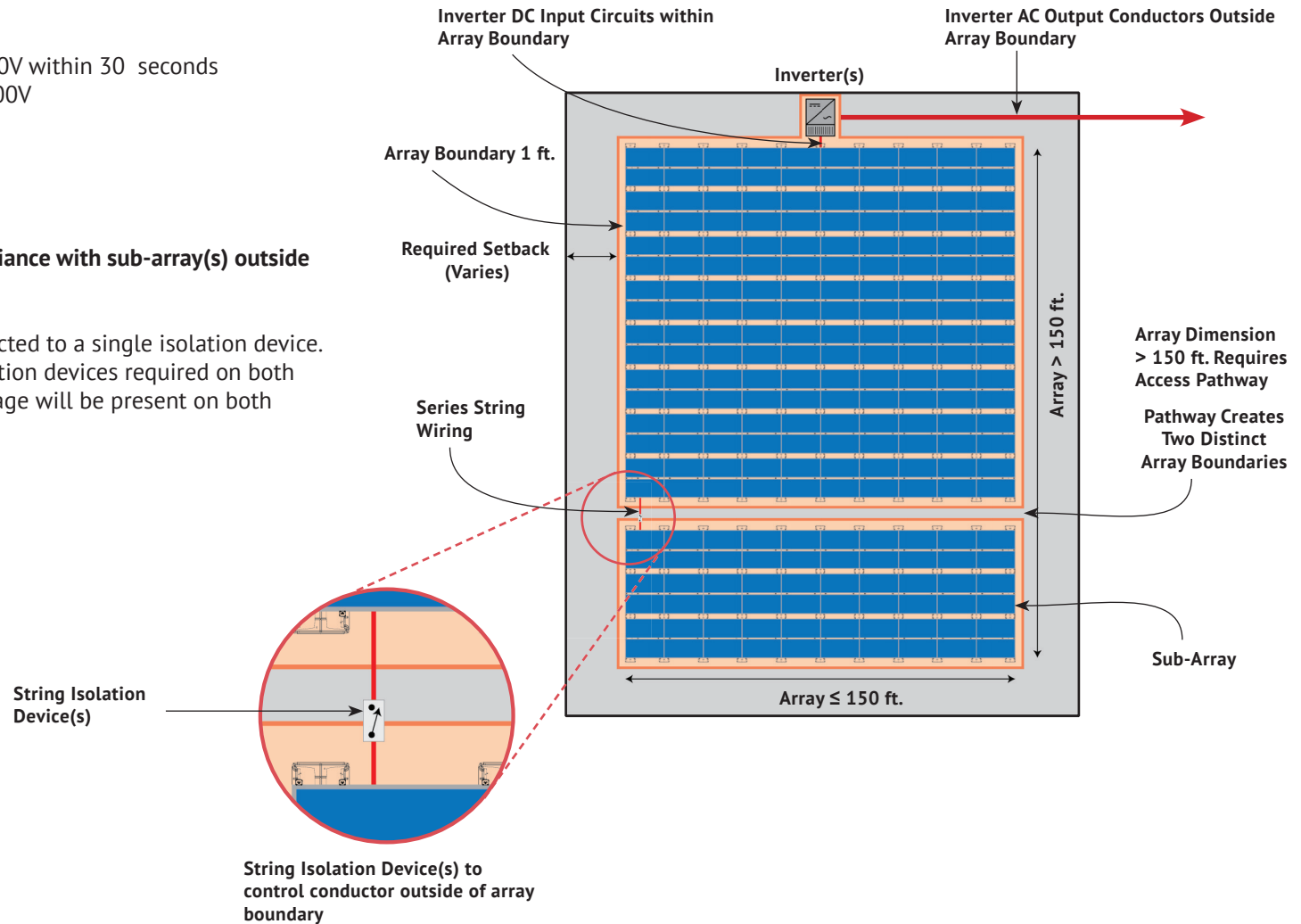

UL 3741 LISTED SYSTEM, CASE 4

Sub-array(s) using MLPEs to control circuits for 690.12(B)(1) and (B)(2) compliance

PV Circuit Voltages

- Outside Array Boundary: $\leq 30V$ within 30 seconds
- Inside Array Boundary: $\leq 1000V$
- Sub Array Boundary: $\leq 80V$ inside within 30 Seconds

Case 4: Maintaining NEC Compliance with sub-array(s) outside of array boundary

- Utilize Module-Level Power Electronics on lower sub-array.
- All modules on the same inverter input must be connected to an MLPE. Upper array utilizes UL3741 listing without MLPEs for compliance.

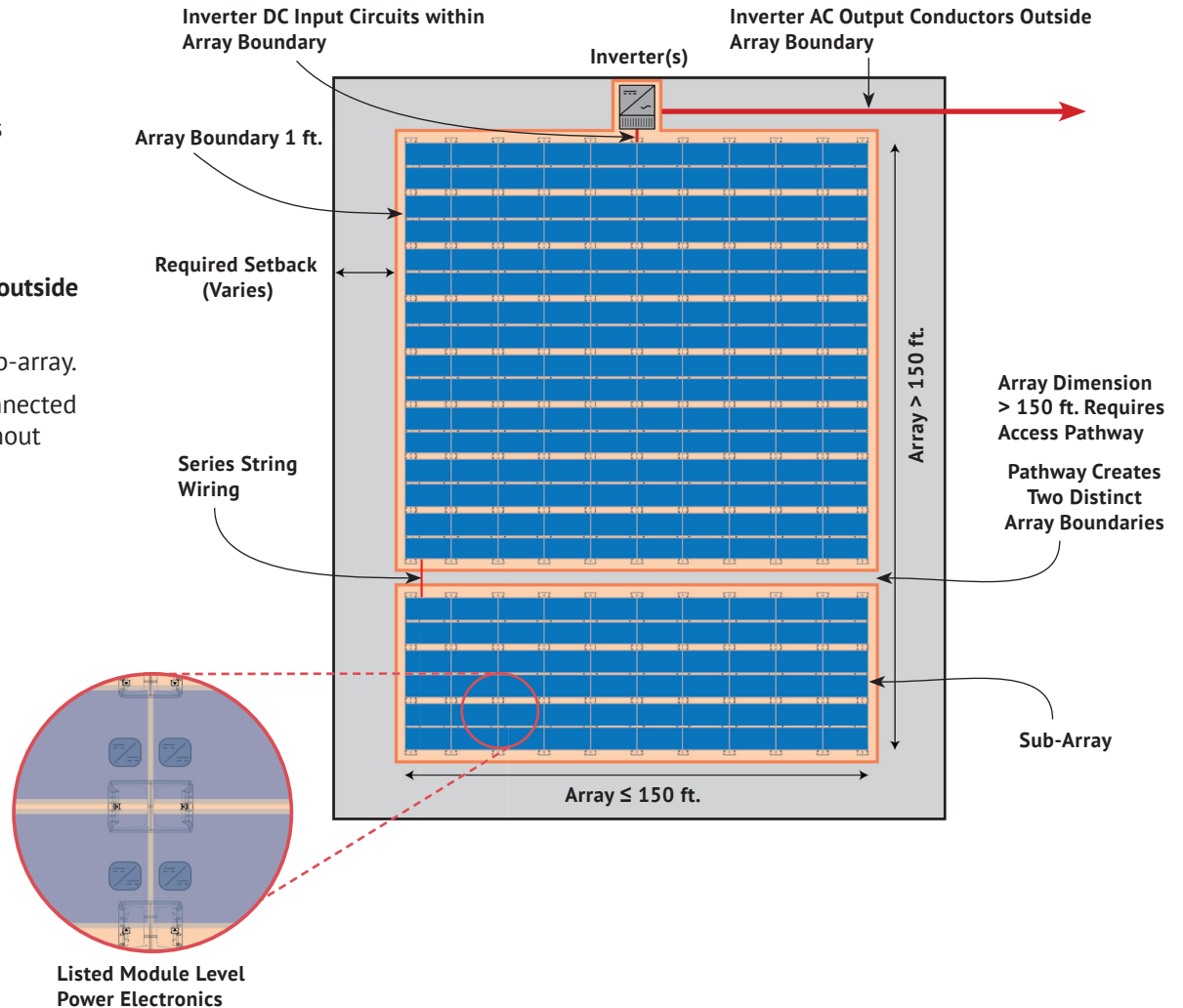

NOTE: When using MLPE devices, review installation instructions for both the MLPE device and Inverter to verify that both devices comply with UL1741 Rapid Shutdown requirements.

UL 3741 WIRE MANAGEMENT GUIDELINES

The RMDT wire management components noted in the list of approved PVHCS equipment on page 2 were evaluated and approved for providing wire protection against potential FF interactions. To achieve wire protection as required per UL 3741, all wires shall be routed such that they are not exposed to potential FF interactions. It is achieved using:

WIRE CLIPS

- Route wires under modules using approved wire clips. *See figures 1&2.*
- Do not allow wires to sag between clips.
- Do not overtighten or pinch wires.
- Utilize wire clips to prevent contact between the wire and the metallic components of the module and racking system.

RACEWAYS

- Protect wires in exposed areas such as inner row spaces and pathways by utilizing the listed raceways on page 2 (RayTray, conduit, etc.). *See figures 3&4.*
- Ensure that PV wire is not exposed to sharp edges when entering or exiting listed raceways.



Figure : 1

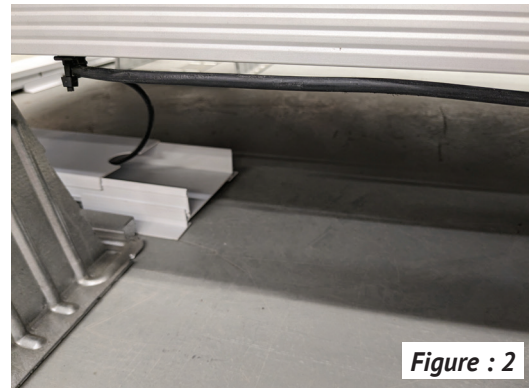

Figure : 2

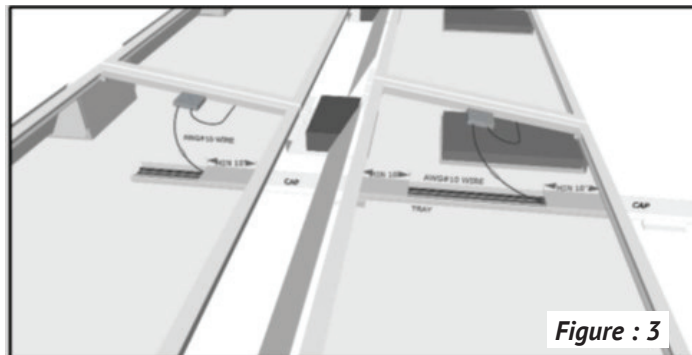
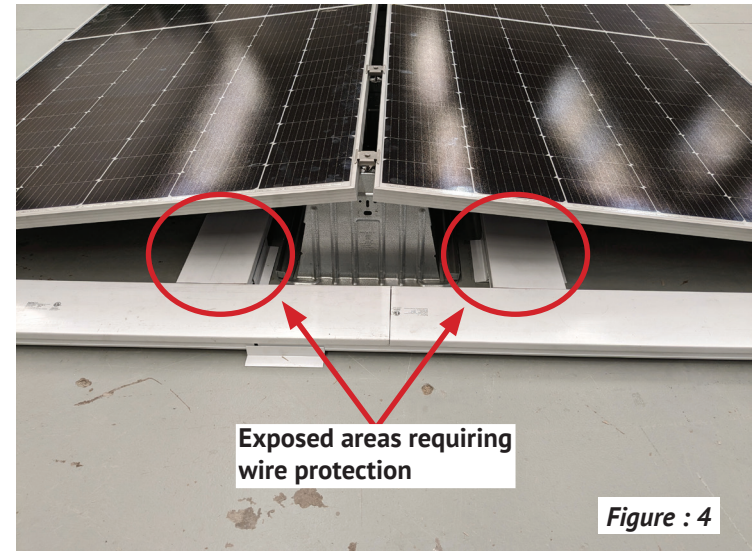

Figure : 3



Exposed areas requiring wire protection

Figure : 4