



ROCKIT[®]

COMPLETE RAIL-LESS RACKING SYSTEM

The RockIt System is an installer-favorite rail-less PV racking solution for composition shingle, standing seam metal, and low slope roofs. Designed in collaboration with installers, RockIt ensures swift and straightforward installation using a single tool. Its innovative design incorporates an easy-to-adjust alignment slide, a top-down leveling system, and logistical intelligence, as there is no need to ship or transport rails. RockIt System conforms to UL 2703, UL 2703A and UL 3741.

FEATURES & BENEFITS

- Patented watertight technology
- Fully integrated bonding
- Top-down leveling system
- North-South adjustability
- Single tool install
- Florida Product Approved for composition shingle roofs

STREAMLINED INSTALLATION WITH ADJUSTABILITY & TOP-DOWN LEVELING



Composition Shingle,
Standing Seam Metal,
Low Slope



Rail-Less



Structural-Attach
Direct-Attach



ROCKIT COUPLING

The fast-installing RockIt Coupling attaches easily to the module frame, bridging the gaps between modules.

SKIRT

The sleek black skirt installs first and acts as an alignment guide for the entire array. The Skirt End Cap does double duty as a skirt coupling device and an aesthetically-pleasing finish.

ROCKIT MOUNT

Featuring integrated bonding pins, the RockIt Mount connects to the Slide and can easily be positioned for fast installation. Features top-down leveling.

ROCKIT COMP SLIDE

Available in four variations, the RockIt Slide allows installation on composition shingle, standing seam metal, and low slope roofs.

FRAME MLPE MOUNT

Attaches and fully bonds MLPE's (Module Level Power Electronics) to the module frame with a single bolt clip.

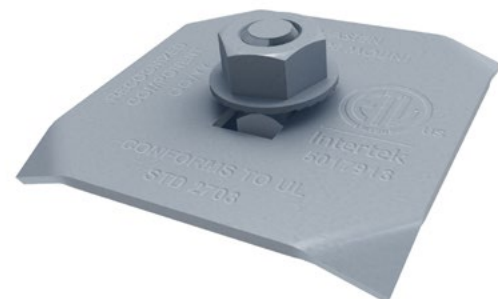

COMPOSITION SHINGLE ROOFS

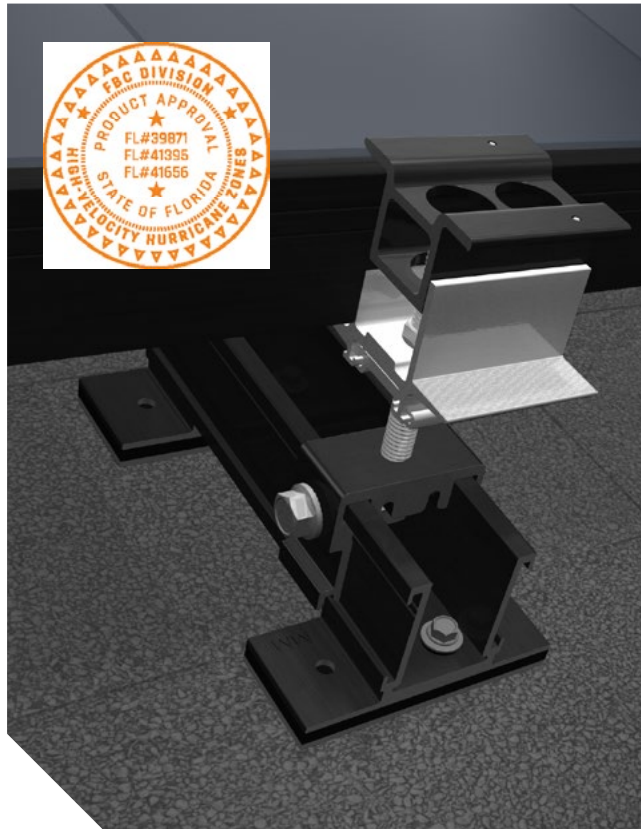

SMART SLIDE

Patent pending, fast installing simple solution for composition shingle roofs. Eliminates the need to pry up shingle courses to install metal flashing.

- Multiple opportunities to find the rafter
- No need for additional material when architectural shingles are not level
- Longer 6.75" slide avoids overlaps in shingle courses
- Integrated flashing utilizes UltraGrip Technology™ to create a watertight seal



ROCKIT SMART SLIDE

METAL ROOFS & LOW SLOPE ROOFS

SIMPLEBLOCK-U

Combine the RockIt Comp Slide with SimpleBlock-U for a fast installation on vertical/double-lock metal standing seam roofs.

- Features an open-ended T-slot for N-S adjustability
- Clamp-to-seam technology
- No roof penetrations required
- Conforms to UL 2703



SIMPLEBLOCK-U

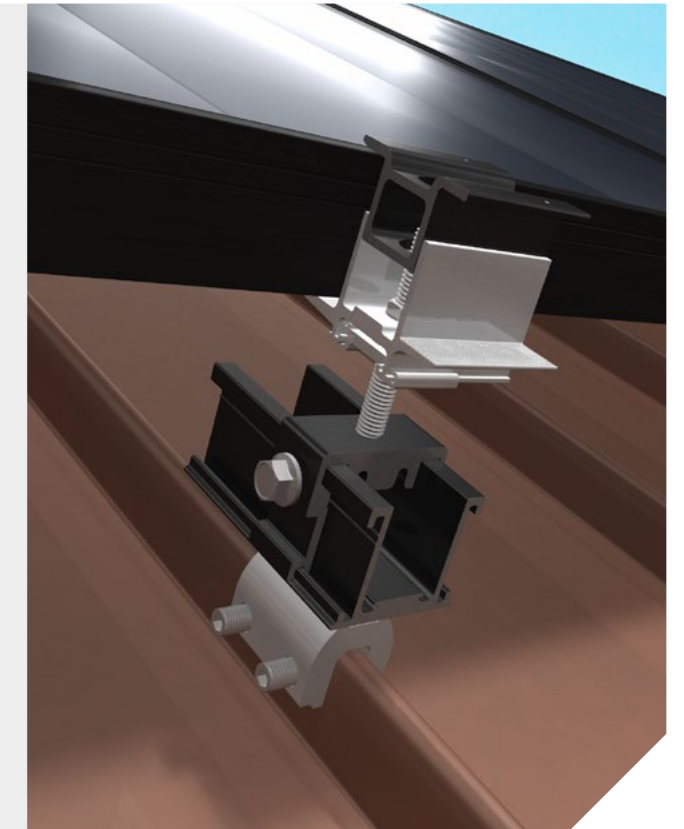

COMP SLIDE

Combine the GF-1 Flashing with the RockIt Slide for a flashed composition shingle roof applications.

- Installs without removing shingles
- One lag bolt for a single penetration
- Compatible with a variety of EcoFasten compression brackets

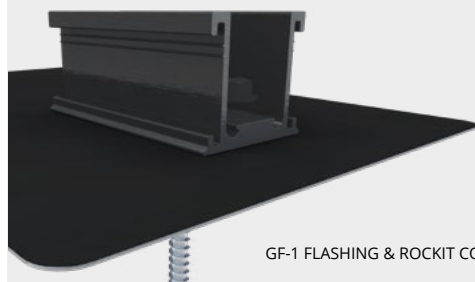

GF-1 FLASHING & ROCKIT COMP SLIDE

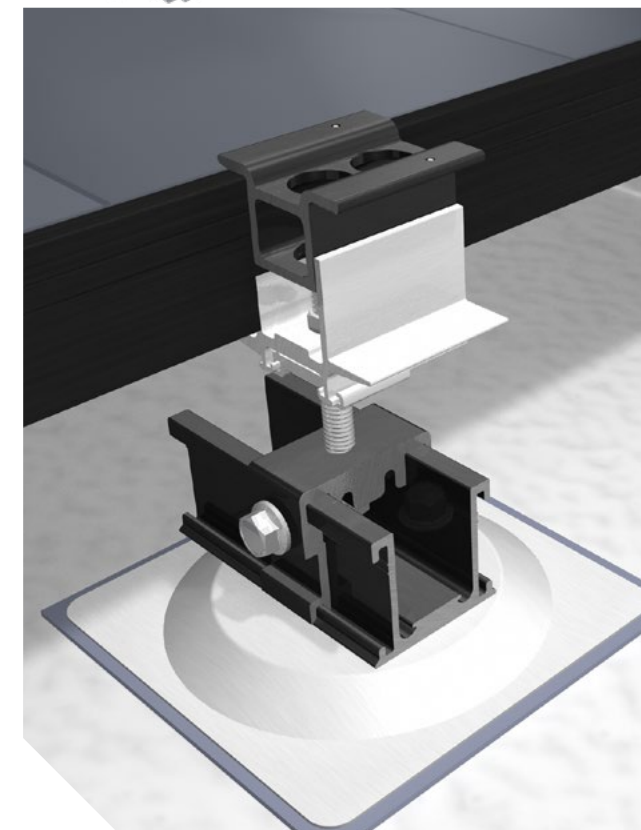
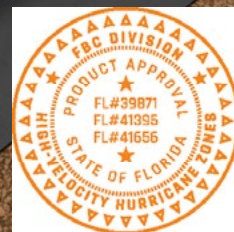

SIMPLEGRIP-SQ

Connect the RockIt Comp Slide with SimpleGrip-SQ for a self-flashed solution on low slope roofs such as rolled asphalt and TPO.

- Installs without cutting into the roof
- UV Ray shielded adhesive prevents degradation
- Four self-drilling screws for optimum uplift and fast installation

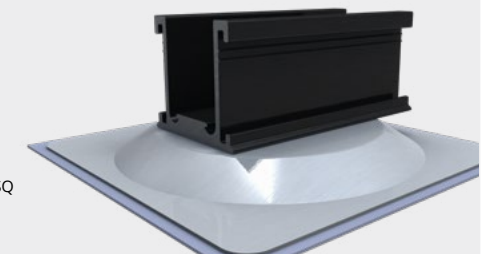

SIMPLEGRIP-SQ

