



GRIDFLEX[™] 10 INSTALLATION GUIDE



UL 3741 PV Hazard Control Installation Addendum

© 2022 by Unirac, Inc. All rights reserved.



GRIDFLEX[™] 10 INSTALLATION GUIDE

TABLE OF CONTENTS

INTRODUCTION	1-2
CERTIFICATION & MARKINGS	3-4
SYSTEM COMPONENTS.....	5-6
APPROVED INVERTERS	7-8
INSTALLATION METHODS.....	9
CONFIGURATION-1.....	10
CONFIGURATION-2.....	11
CONFIGURATION-3.....	12
WIRE MANAGEMENT	13-15

INTRODUCTION

This manual describes the procedure to install the GridFlex 10 product to meet the requirements of the UL3741 PV Hazard Control Standard. All installers must thoroughly read this manual and have a clear understanding of the installation procedures prior to installation. Failure to follow the methods and procedures outlined in this manual may result in injury and/or damage to property.

The GridFlex 10 Photovoltaic Hazard Control System (PVHCS) is a UL 3741 Listed system that complies with NEC 690.12(B)(2)(1), when installed by qualified individuals as per the installation procedures described in the GridFlex 10 System installation manual and this addendum. In the following pages of this addendum, various example configurations of system designs that comply with 690.12(B)(2) are mentioned.

Brief Background of 2020 NEC 690.12

As per 2020 NEC 690.12 Rapid Shutdown of PV Systems on buildings, All PV arrays installed on or in buildings shall include rapid shutdown functions to reduce shock hazard for Fire Fighters (FF) in accordance with 690.12(A) through (D):

Brief Background of UL3741

UL3741 provide a means for evaluation of PV Hazard Control components, equipment and systems that provide a reduced level of shock hazard from energized PV system equipment and circuits located within the PV array after the operation of hazard control initiation function(s) where required, such as but not limited to any PV Rapid Shutdown Equipment (PVRSE) or PV Rapid Shutdown Systems (PVRSS) that comply with UL 1741 in the United States and CSA C22.2 No 330 in Canada.

Controlled Conductors for Rapid Shutdown

- DC circuits of PV system
- Inverter output circuits originating from inverters located within array boundary

Controlled Parameters for Rapid Shutdown

- Outside Array Boundary: $\leq 30V$ within 30 seconds
- Inside Array Boundary:
 - (1) Listed PV Hazard Control System (UL 3741)
 - (2) PV array with appropriate wire management to limit conductive parts exposure. *See Pages 13, 14 & 15*

IMPORTANT: Requirements for PV arrays addressed in UL 3741 are intended for compliance with the National Electrical Code (NEC), NFPA 70, 2017 and later editions and their requirements for controlling electrical shock hazards inside the array boundary as addressed in NEC section 690.12(B)(2), Rapid Shutdown of PV Systems on Buildings and with the Canadian Electrical Code (CE Code) C22.1. The inverters listed in the “Approved Inverters” section within this PVHCS additionally comply with the 30V in 30 seconds requirements outside the PV array as required in 690.12 (B)(1).

DEFINITIONS

INITIATION DEVICES

Device(s) that initiate the rapid shutdown function of the PV system

EQUIPMENT

Equipment that performs rapid shutdown functions other than initiation devices, such as listed disconnect switches, circuit breakers, or control switches.

ARRAY

NEC defines the array as a mechanically and electrically integrated grouping of modules with support structure, including any attached system components such as inverter(s) or dc-to-dc converter(s) and attached associated wiring. This indicates the GridFlex 10 Racking and collocated inverters are part of the array.

ARRAY BOUNDARY

Per NEC 690.12(B), the zone extending 1ft from array in all directions. This indicates that the array boundary can extend 1ft from the edge of the GridFlex 10 racking, inverter or module.

INSTALLER'S RESPONSIBILITY

- Ensure that GridFlex 10 and other products are appropriate for the specific installation and are designed for the installation environment.
- Ensure all electrical installation and procedures should be conducted by a licensed and bonded electrician or solar contractor.
- Comply with all applicable local or national building and fire codes, including any that may supersede this manual.
- Ensure provided information is accurate and appropriate. Issues resulting from inaccurate and inappropriate information are the installer's responsibility.
- Ensure the system is grounded and bonded to meet the requirements of the National Electric Code.
- Disconnect AC power before servicing or removing modules, AC modules, microinverters and power optimizers.
- Ensure routine maintenance of a module or panel shall not involve breaking or disturbing the bonding path of the system and all work must comply with national, state and local installation procedures, and safety standards.
- If loose components or loose fasteners are found during periodic inspection, re-tighten immediately. Any components showing signs of corrosion or damage that compromise safety must be replaced immediately.
- Ensure bare copper grounding wire does not contact aluminum and zinc-plated steel components, to prevent risk of galvanic corrosion.
- Review module manufacturer's documentation for compatibility and compliance with warranty terms and conditions.
- Use only Unirac parts or parts recommended by Unirac; substituting parts may void any applicable warranty.
- Installers must refer to the GridFlex 10 installation manual for complete installation instructions.

A warning icon consisting of a black triangle with a white exclamation mark inside, set against an orange background.

**IDENTIFIES CONDITIONS OR PROCEDURES,
WHICH IF NOT FOLLOWED, COULD RESULT IN
SERIOUS INJURY, DEATH, OR PROPERTY DAMAGE.**

A caution icon consisting of a black triangle with a white exclamation mark inside, set against a yellow background.

**IDENTIFIES CONDITIONS OR PROCEDURES,
WHICH IF NOT FOLLOWED, COULD RESULT IN
SERIOUS DAMAGE OR FAILURE OF EQUIPMENT.**



GRIDFLEX 10

CERTIFICATION & MARKINGS

CONFORMS TO STD ANSI/UL 3741

Maximum Photovoltaic Hazard Control System (PVHCS) Voltage: 1000V

UL3741 LISTED



Intertek
311037

MARKINGS

Certification marking is located on the North Rail as shown

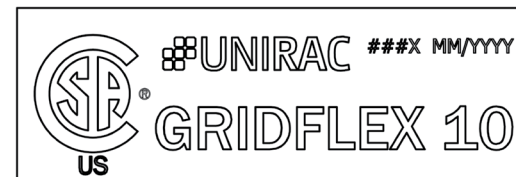
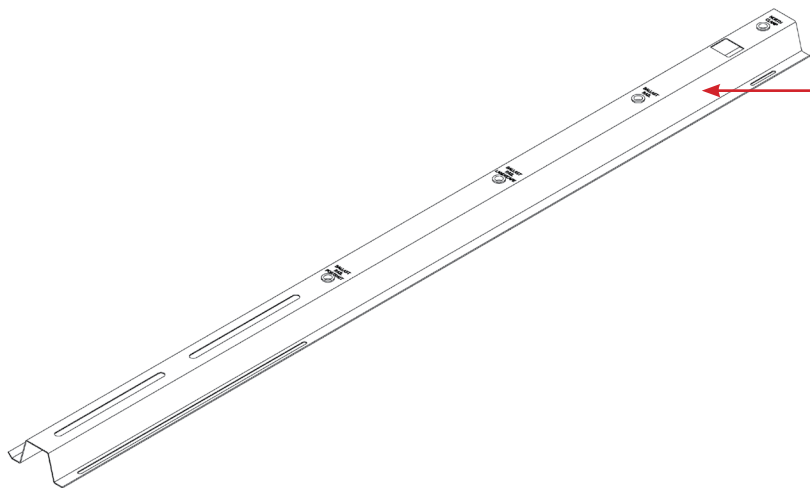



MARKINGS (CONT.)

- Verify all rapid shut down switches are marked with a label indicating the function of the rapid shut down switch.
- Attach one label at or near each rapid shut down switch.
- Labels are provided with the racking by Unirac. Please contact your salesperson if you need additional labels.

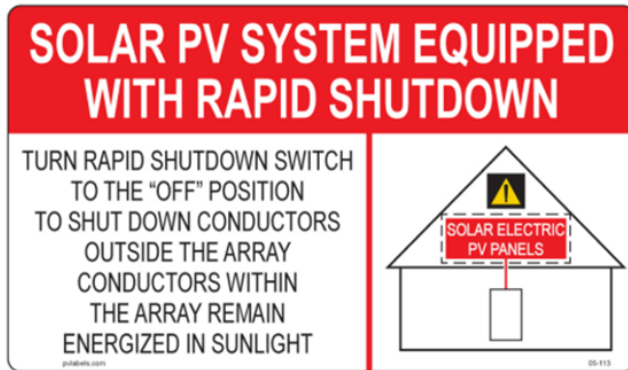

Following are the list of approved PV Hazard Control Equipment or Components evaluated at 1000V Max System Voltage:

(Not all listed items must be implemented in a single system to achieve compliance to UL3741. Rather these are the items approved for use to meet the criteria outlined in this manual)

1. MODULES

All Type 1, 2, and 29 Modules listed in GridFlex 10 Installation Guide *except* the following modules:

MANUFACTURER	MODEL
Jinko	JKMxxxN-72HL4-BDV
Q Cells	Q.PEAK DUO XL G11S.3/BFG
Trina	TSM-xxxNEG19RC.20
Waaree	Bi-55-540
ZNShine	ZXM8-TPLDD132-660/M

2. GridFlex 10 System Components

3. Wire Clips (UL 62275 Listed)

Hellermann Tyton Cable Ties & Edge Clips (Mnfr PNs 111-01561, 111-01564, 156-02224 & 156-02226)

4. PV Connectors (UL 6703 Listed) shall be compatible and approved for the application.

5. PV Wire (UL 4703 Listed)

6. RayTray v2 Solar Wire Management System (UL 870 Listed)

7. Listed Conduit (all sizes apply)

- Electrical Metallic Tubing (EMT) (Sizes 3/4" and greater) (UL 797 Listed)
- Rigid Metal Conduit (RMC) (Sizes 3/4" and greater) (UL 6 Listed)
- Intermediate Metal Conduit (IMC) (Sizes 3/4" and greater) (UL 1242 listed)
- Flexible Nonmetallic Conduit (Sizes 3/4" and greater) (UL1660 Listed)
- PVC - Schedule 40 or 80 (Sizes 3/4" and greater) (UL 651)

8. MLPE DEVICES

It is installer's responsibility to check compatibility between MLPEs and string inverters.

MANUFACTURER	MODEL
APsmart	RSD-D-15-(1000 or 1500) RSD-D-20-(1000 or 1500) RSD-S-PLC-A
JMTHY/SMA America	JMS-F
NEP	PVG-1 PVG-2 PVG-3
Sungrow	SP600S
Tigo	TS4-A-2F TS4-A-F TS4-A-O TS4-A-S TS4-R-F TS4-R-O TS4-R-S TS4-X-F TS4-X-O TS4-X-S

APPROVED ELECTRICAL INVERTERS (UL 1741 LISTED)

Inverters that were evaluated to meet the rapid shutdown requirements in conjunction with other components as part of a PVRSS, such as attenuators and/or initiation devices, must be installed with those components to comply with UL 3741 systems.

MANUFACTURER	MODEL
Canadian Solar Inverters	CSI-50KTL-CT
	CSI-60KTL-CT
	CSI-30KTL-GS-FLB
	CSI-40KTL-GS-FLB
	CSI-60KTL-GS-B
	CSI-25K-T480GL01-UB
	CSI-30K-T480GL01-UB
	CSI-36K-T480GL01-UB
	CSI-40K-T480GL01-UB
	CSI-50K-T480GL01-UB
	CSI-60K-T480GL01-UB
	CSI-66K-T480GL01-UB
	CSI-75K-T480GL02-U
	CSI-80K-T480GL02-U
	CSI-90K-T480GL02-U
	CSI-100K-T480GL02-U
	CSI-25K-T480GL03-U
	CSI-36K-T480GL03-U
	CSI-40K-T480GL03-U
	CSI-50K-T480GL03-U
CSI-60K-T480GL03-U	
CSI-75K-T480GL03-U	
CSI-80K-T480GL03-U	
CSI-90K-T480GL03-U	
CSI-100K-T480GL03-U	
Chint Inverters	CPS SCA25KTL-DO/US-208
	CPS SCA36KTL-DO/US-480
	CPS SCA50KTL-DO/US-480
	CPS SCA60KTL-DO/US-480
	CPS SCA25KTL-DO-R/US-480

MANUFACTURER	MODEL
Fronius Inverters	Fronius Symo Advanced 10.0-3 208-240 (may be followed by Lite)
	Fronius Symo Advanced 12.0-3 208-240 (may be followed by Lite)
	Fronius Symo Advanced 15.0-3 480 (may be followed by Lite)
	Fronius Symo Advanced 20.0-3 480 (may be followed by Lite)
	Fronius Symo Advanced 22.7-3 480 (may be followed by Lite)
	Fronius Symo Advanced 24.0-3 480 (may be followed by Lite)
NEP	Neptune30K
	Neptune33K
	Neptune36K
	Neptune40K
	Neptune50K
	Neptune60K
	Neptune75K
Neptune100K	
SMA Inverters	STP 50-US-40
	STP 33-US-41
	STP 50-US-41
	STP 62-US-41
	STP 20-US-50
	STP 25-US-50
STP 30-US-50	

APPROVED ELECTRICAL INVERTERS (UL 1741 LISTED) Continued

MANUFACTURER	MODEL
Solectria Inverters	SolectriaRenewablesPVI25TL-208
	SolectriaRenewablesPVI25TL-480-R
	SolectriaRenewablesPVI50TL-480
	SolectriaRenewablesPVI60TL-480 PVI-36TL-480-V2
Sungrow Inverters	SG36CX-US
	SG60CX-US
Solis Inverters	Solis-25K-US (followed by -US-SW, -US-F-SW or -US-LSW)
	Solis-30K-US (followed by -US-SW, -US-F-SW or -US-LSW)
	Solis-36K-US (followed by -US-SW, -US-F-SW or -US-LSW)
	Solis-40K-US (followed by -US-SW, -US-F-SW or -US-LSW)
	Solis-50K-US (followed by -US-SW, -US-F-SW, -US-F-LSW or -US-LSW)
	Solis-60K-US (followed by -US-F-SW, or -US-F-LSW)
	Solis-66K-US (followed by -US-F-SW, or -US-F-LSW)
	S5-GC75K-US
	S5-GC80K-US
	S5-GC90K-US
	S5-GC100K-US
	S5-GC125K-US
	S6-GC25K-US
	S6-GC30K-LV-US
	S6-GC33K-US
	S6-GC36K-US
	S6-GC40K-US
S6-GC50K-US	
S6-GC60K-US	

MANUFACTURER	MODEL
GoodWe Inverters	GW50K-SMT-US
	GW60K-SMT-US
	GW6000A-MS
	GW7600A-MS
	GW8600A-MS
	GW9600A-MS
	GW5000-MS-US30
	GW6000-MS-US30
	GW7600-MS-US30
	GW9600-MS-US30
	GW11K4-MS-US30

INSTALLATION METHODS PER UL 3741 AND NEC 690.12

The following PV Design configurations are recommended by Unirac to show GridFlex 10 system comply with NEC 690.12(B). Compliance is not limited to these configurations.

CONFIGURATION 1: Array(s) with Listed UL 3741 PV Hazard Control System – *See page 10*

CONFIGURATION 2: Array(s) with Listed UL 3741 PV Hazard Control System & Sub Array(s) with MLPE(s) – *See page 11*

CONFIGURATION 3: Array(s) with Listed UL 3741 PV Hazard Control System & Sub Array(s) within same Array Boundary – *See page 12*

Controlled Parameters after Rapid Shutdown Initiation for all configurations

Outside Array Boundary: $\leq 30V$ within 30 seconds

Inside Array Boundary: $\leq 1000V$

CONFIGURATION-1

Array(s) with Listed UL 3741 PV Hazard Control System

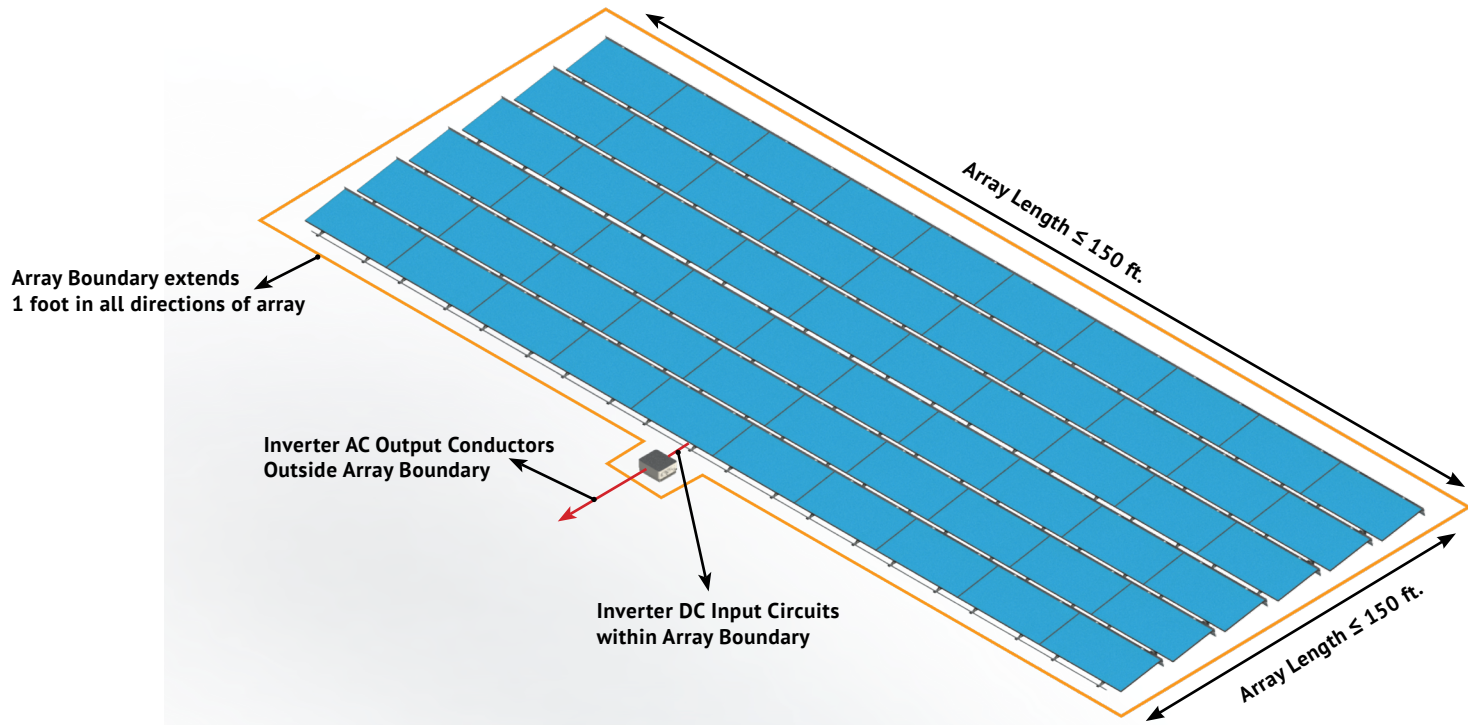

1. By using listed UL3741 PVHCS, array(s) complies with NEC 690.12(B)
2. Inverter output circuits (AC) that are outside of the array boundary and comply with NEC 690.12(B)(1) once rapid shutdown is initiated.
3. After Rapid Shutdown Initiation, inverter input circuits (DC) do not require additional measures to reduce string voltages per NEC 690.12(B)(2)(1) as they are within the array boundary.

NOTE:

For controlled parameters information See page 9

Example array not specifically verified by Intertek.

CONFIGURATION-2

*Array(s) with Listed UL 3741 PV Hazard Control System
 & Sub Array(s) with MLPE(s)*

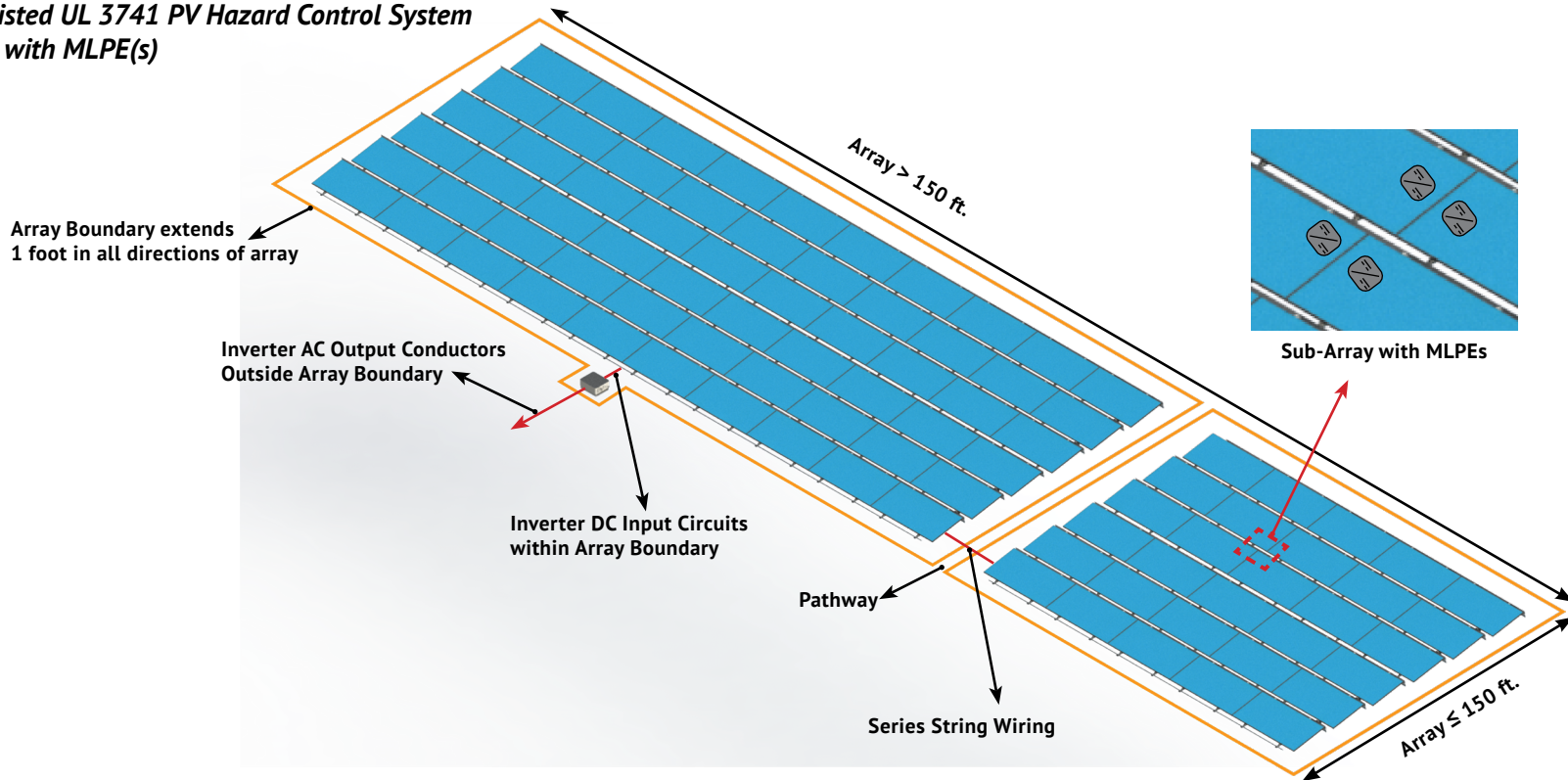

1. Array(s) uses UL3741 listed PVHCS and complies with 690.12(B)(1)
2. Sub array(s) uses MLPE(Module Level Power Electronics) and complies with 690.12(B)(2) by maintaining
 - a. ≤ 80V within 30 seconds inside array boundary
 - b. ≤ 30V within 30 seconds outside the array boundary

NOTE:
 It is imperative to thoroughly review installation instructions for both the MLPE device and Inverter to verify that both devices comply with UL1741 Rapid Shutdown requirements while using MLPE devices.
 Example array not specifically verified by Intertek.

CONFIGURATION-3

*Array(s) with Listed UL 3741 PV Hazard Control System
& Sub Array(s) within same Array Boundary*

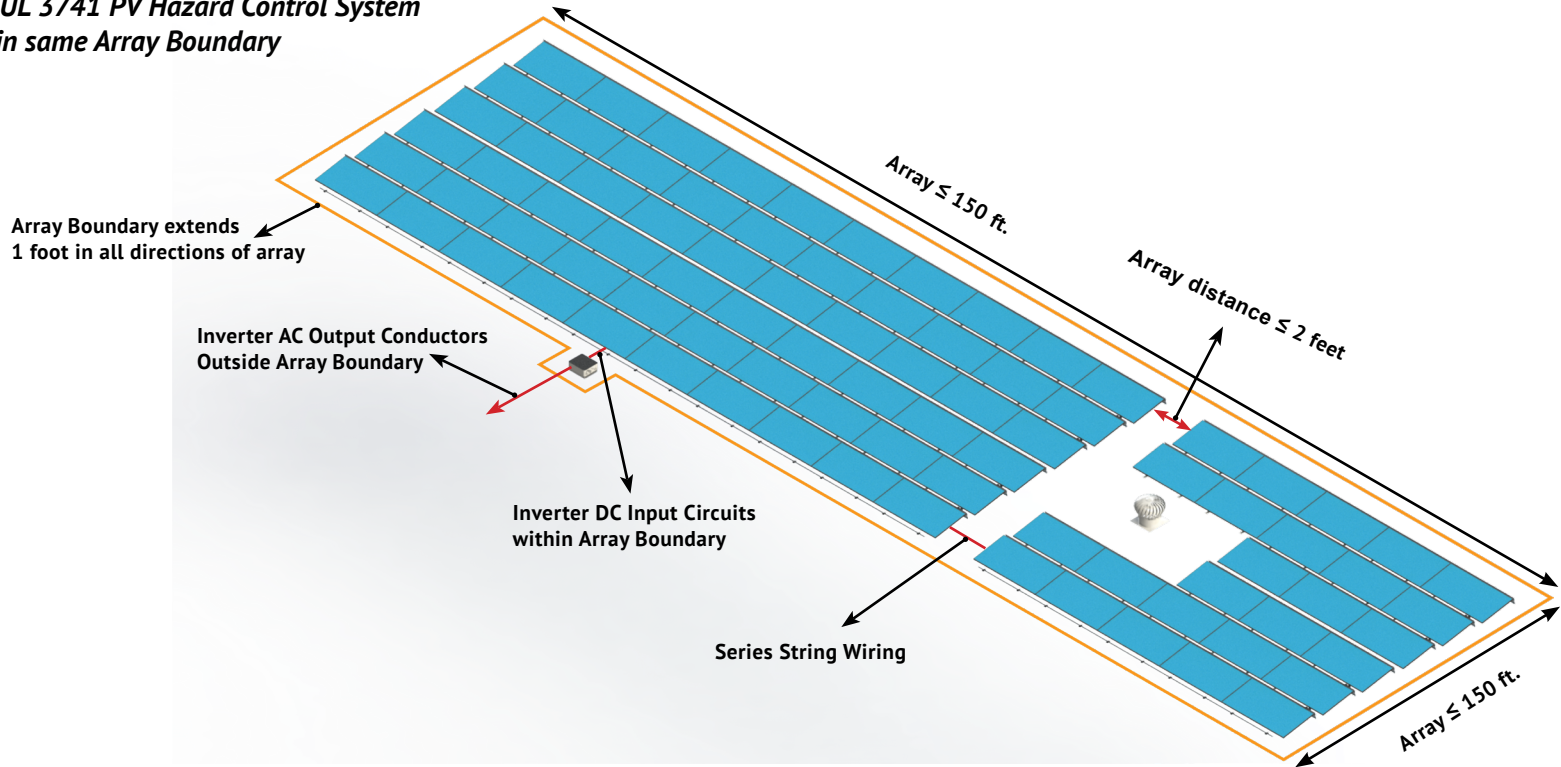

1. When array(s) and all array components are located not more than 2 feet apart, this results in a single array boundary.
2. Array(s) and sub array(s) uses UL3741 listed PVHCS and complies with 690.12(B)(2)(1)

NOTE:

For controlled parameters information See page 9
Example array not specifically verified by Intertek.

UL 3741 WIRE MANAGEMENT GUIDELINES

The GridFlex 10 wire management components noted in the list of approved PVHCS equipment on **page 5** were evaluated and approved for providing wire protection against potential FF interactions. To achieve wire protection as required per UL 3741, all wires shall be routed such that they are not exposed to potential FF interactions. It is achieved using:

WIRE CLIPS

- Route wires under modules using approved wire clips. *See figure 1.*
- Do not allow wires to sag between clips.
- Do not overtighten or pinch wires.
- Utilize wire clips to prevent contact between the wire and the metallic components of the module and racking system.

WIREWAY

- Protect wires in exposed areas such as inner row spaces and pathways by utilizing the listed wireway options on **page 5** (RayTray, conduit, etc.). *See figure 2*
- Ensure that PV wire is not exposed to sharp edges when entering or exiting listed wireway.

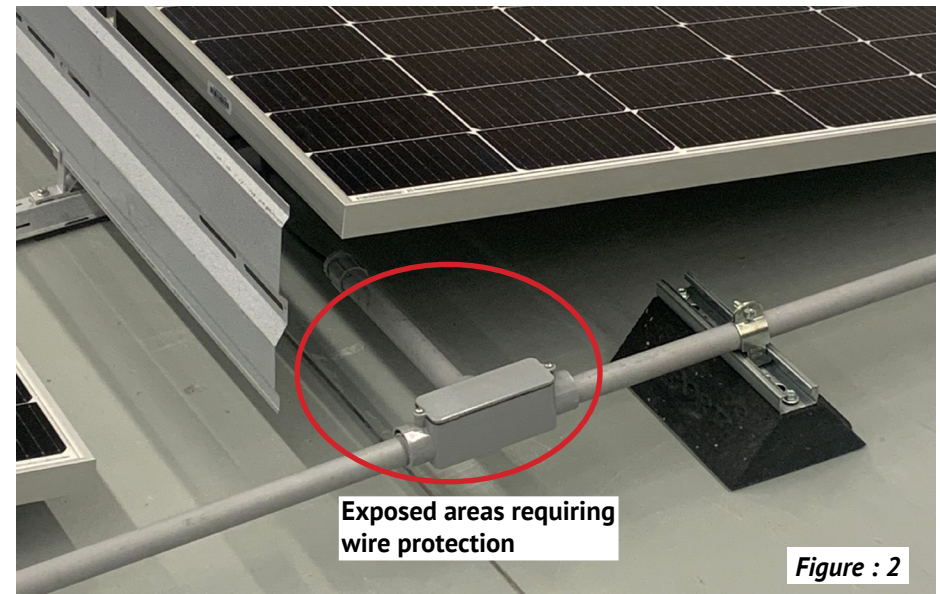
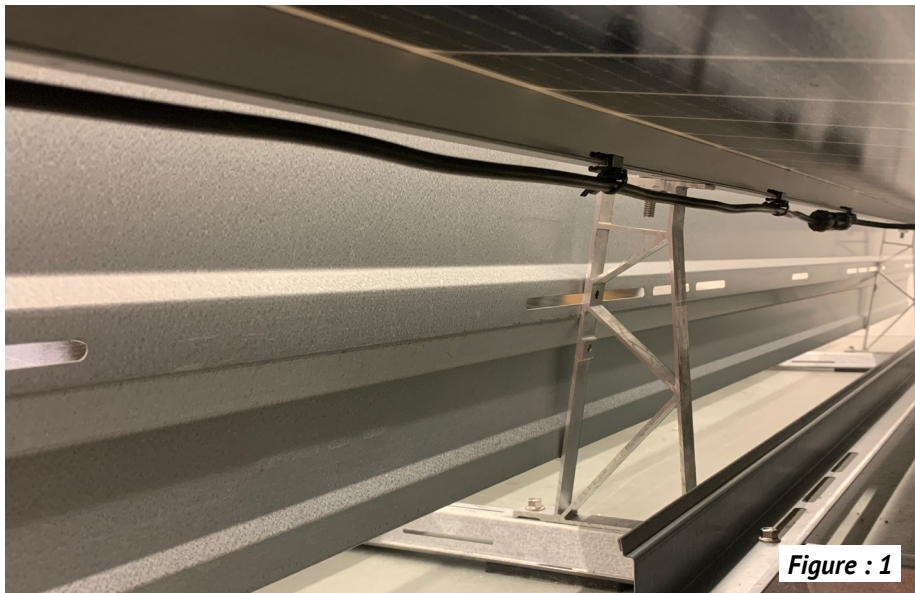

WIRE MANAGEMENT OPTIONS

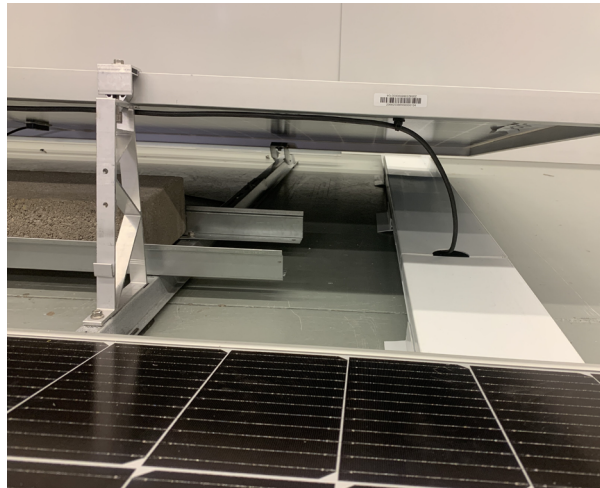
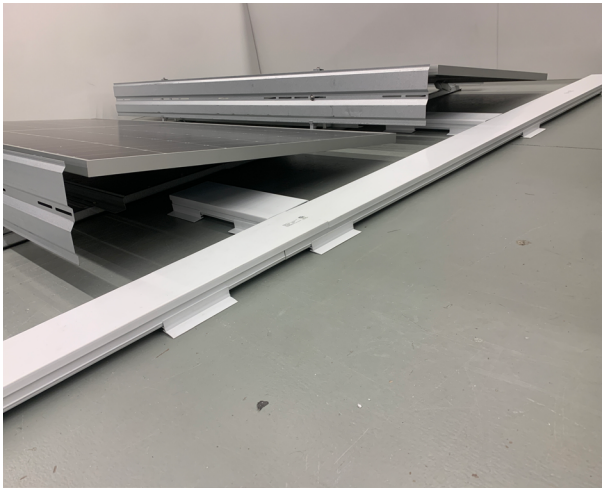

OPTION 1: USING RAYTRAY OR ECOTRAY

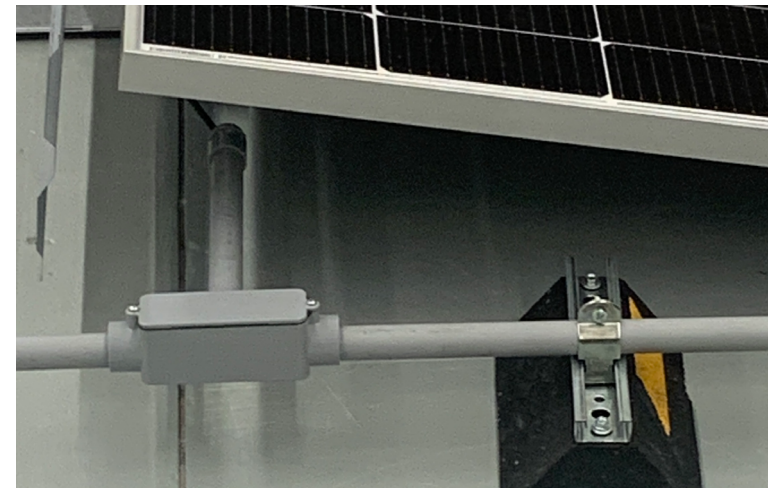
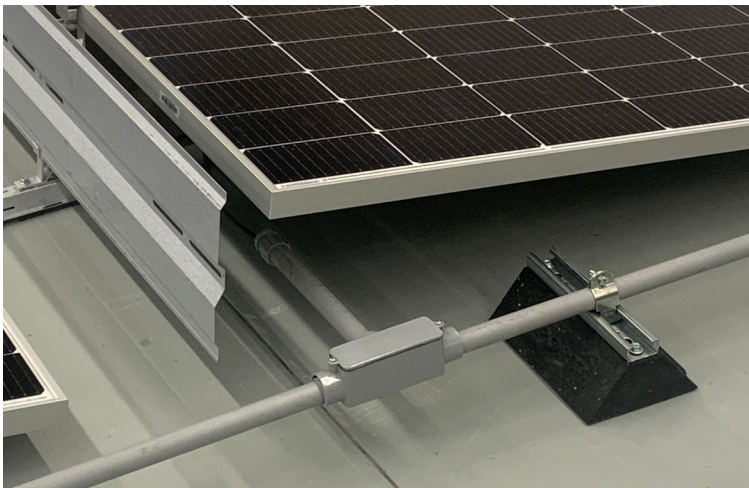

OPTION 2: USING RIGID NONMETALLIC CONDUITS

WIRE MANAGEMENT OPTIONS

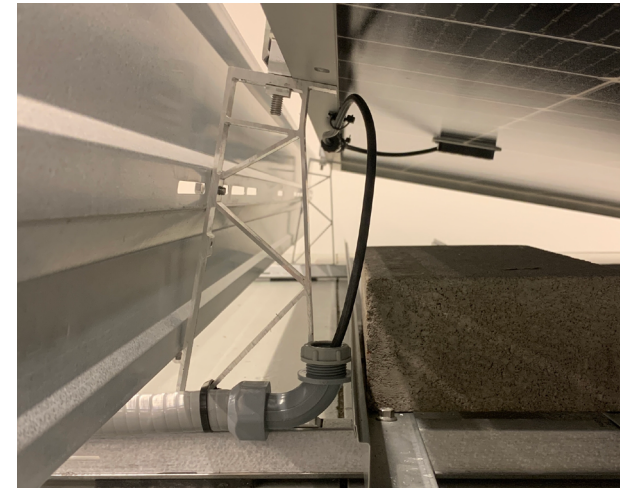
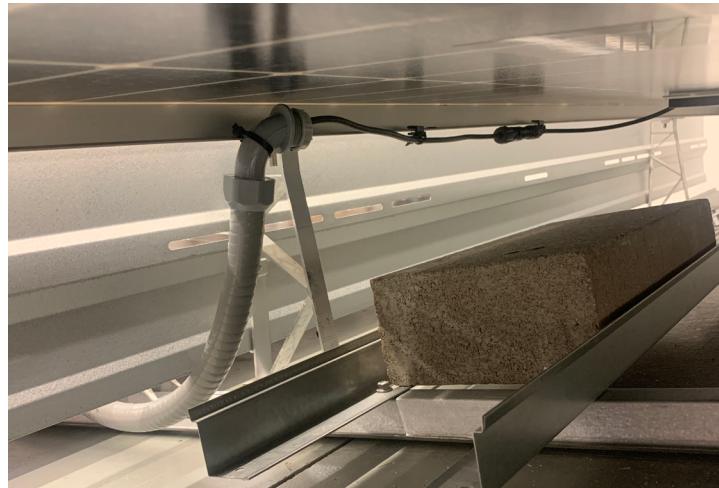

OPTION 3: USING FLEXIBLE NONMETALLIC CONDUITS

Use Hellermann Tyton products 111-01561 or 111-01564 to mount nonmetallic conduits